

10' T-WALL

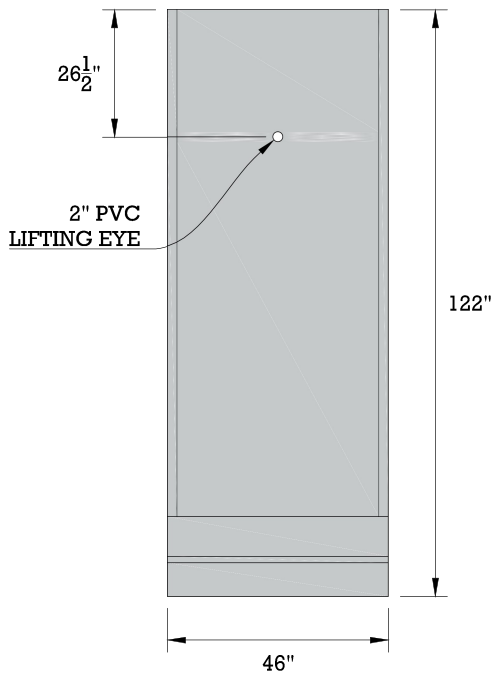

FRONT VIEW

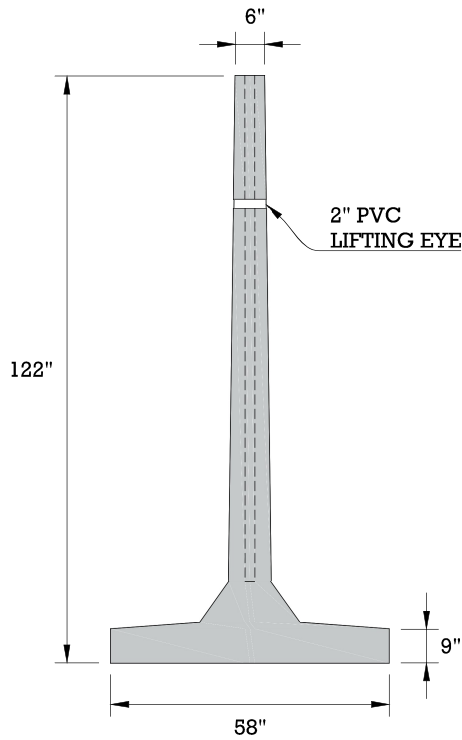

SIDE VIEW

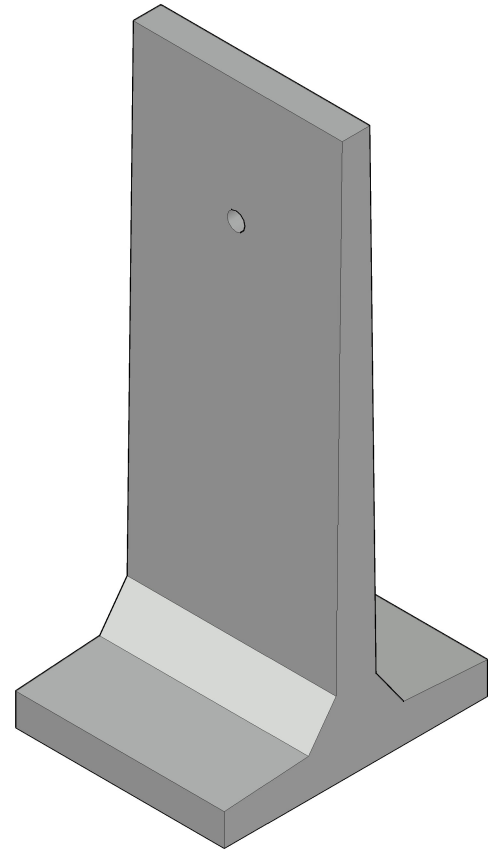

ISOMETRIC VIEW

	WEIGHT (LBS)	SPECIFICATIONS
	5,800	Concrete: 4000PSI @ 28 days
		Reinforcement: ASTM A615/A615M GRADE 60 ASTM A1064/A1064M-16B

JMI
 Jamestown Macadam, Inc.
www.jamestownmacadam.com
 716-665-4504