

BARRIER BLOCK 2'X2'X5' STRAIGHT

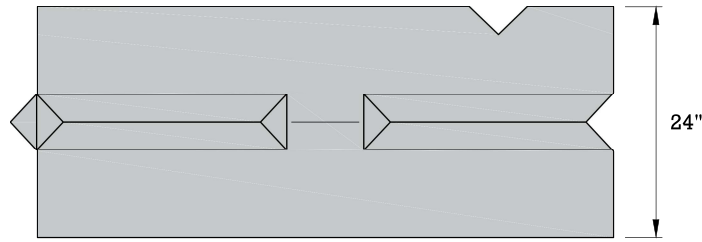

TOP VIEW

THIS PORTION OF BLOCK
VOIDED OUT FOR CABLE
OR U-ANCHOR

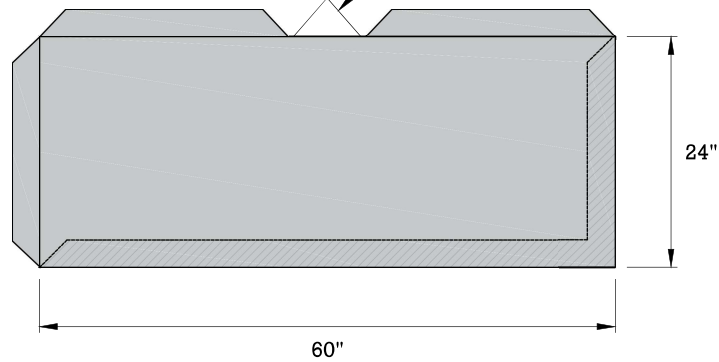

FRONT VIEW

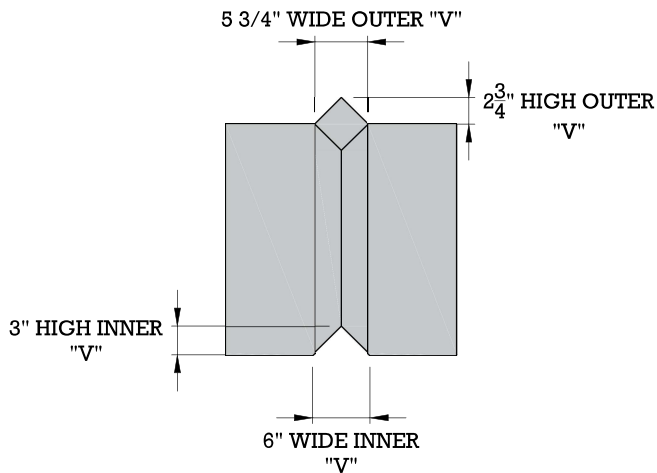

END VIEW

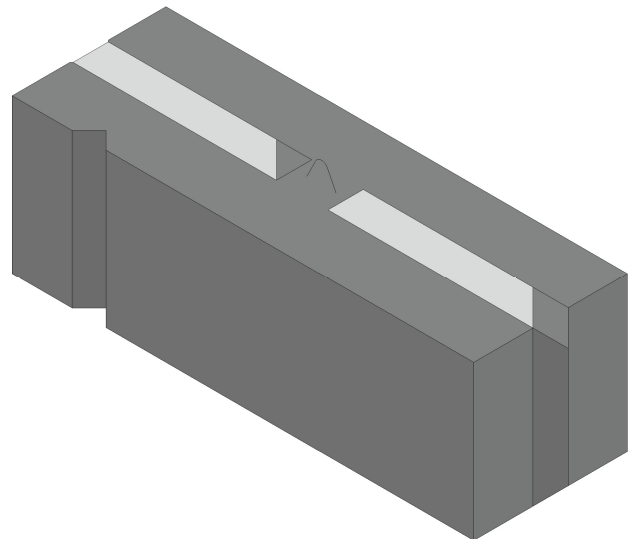

ISOMETRIC VIEW

NOTES:

Weight: 2,550 Lbs.

Volume: 24.0 ft³

Faces Available: Plain, Slate & Random Stack Stone

-ORIGINAL DESIGN AND DIMENSIONS BASED OFF OF WORLD BLOCK INC.

