

CATCH BASIN RISER 2X4

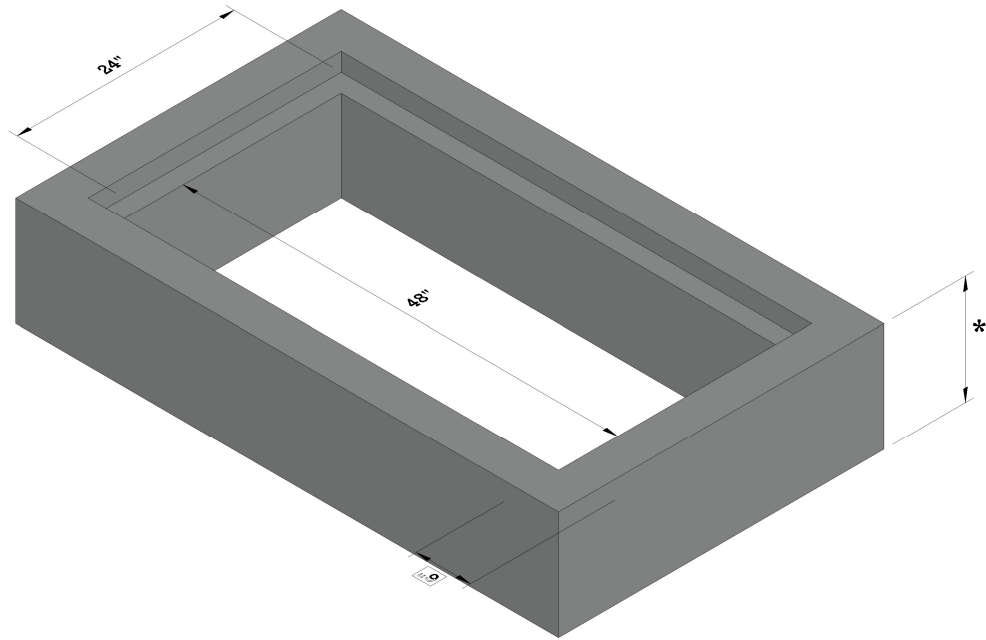

ISOMETRIC VIEW

*			WEIGHT (LBS)	SPECIFICATIONS	
6"			505	Concrete: 4000PSI @ 28 days	
12"			1,010	Reinforcement: ASTM A615 GRADE 60 ASTM A185 GRADE 65	18" Diameter knockouts on sidewalls
				Structure is designed to meet HS 20-44 loading requirements	
				Frame and Grates Available; Heavy Duty & Bicycle Safe	
				Concrete Risers Available	

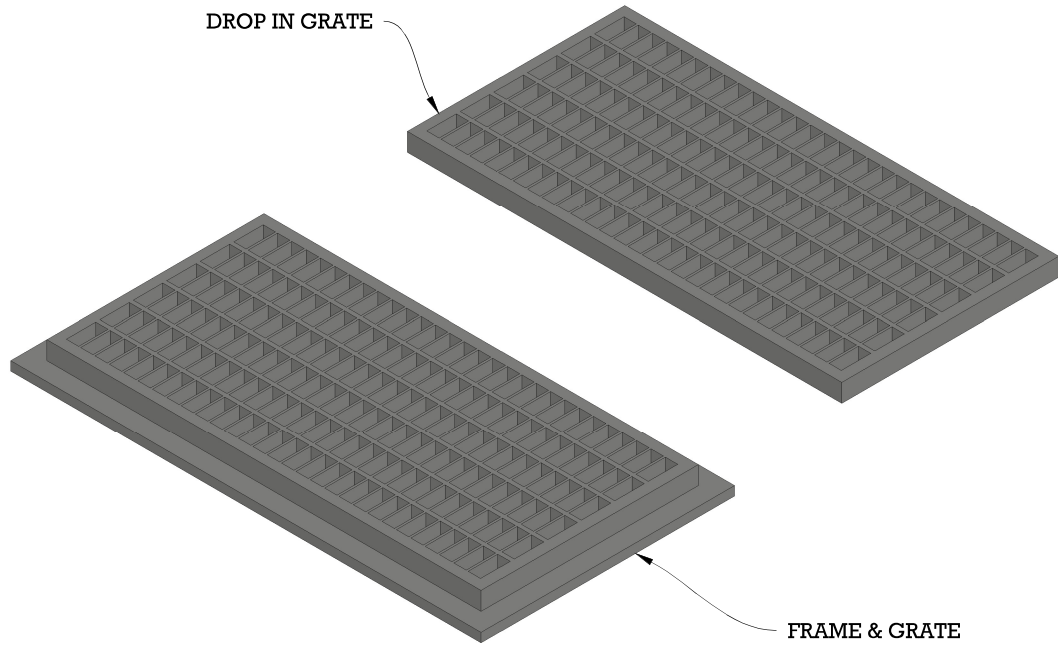